

Remote Learning – Class 4

Friday 12th November 2021

12.11.21

Maths

Perimeter of rectilinear shapes

- Today in Maths we are looking at the perimeter of rectilinear shapes.
- To understand what the perimeter of rectilinear shapes is please use the link below.
- Link: <https://whiterosemaths.com/homelearning/year-4/week-9-measurement-length-perimeter/>

Perimeter of rectilinear shapes

- 1 The length of each square on the grid is 1 cm.
Work out the perimeter of the shapes.

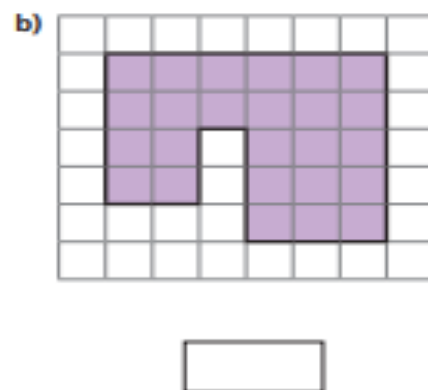
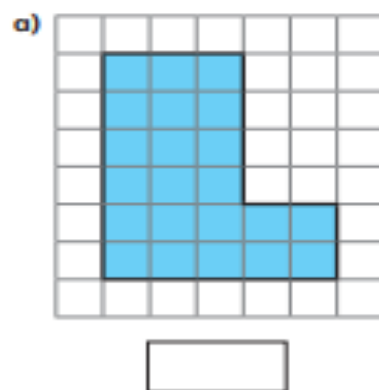

- 2 Work out the perimeter of the shape.

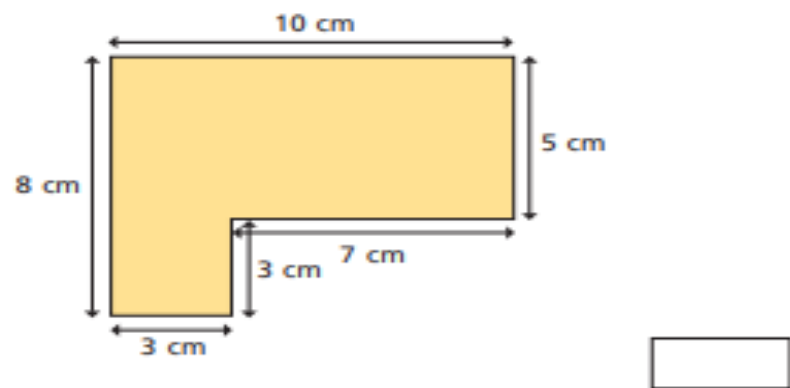

- 3 a) Work out the missing lengths and label them on the diagram.

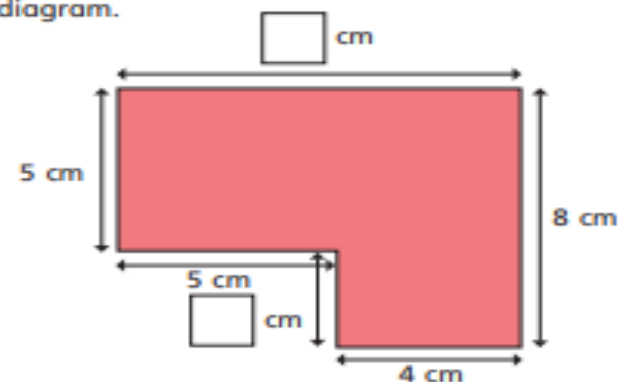

- b) What is the perimeter of the shape?

- 4 Work out the perimeter of each shape.

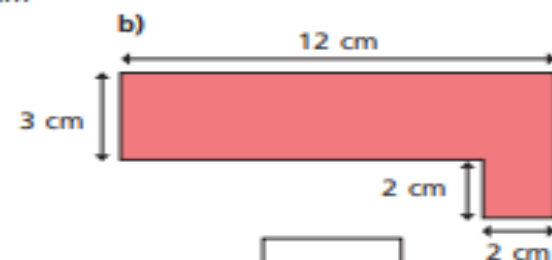
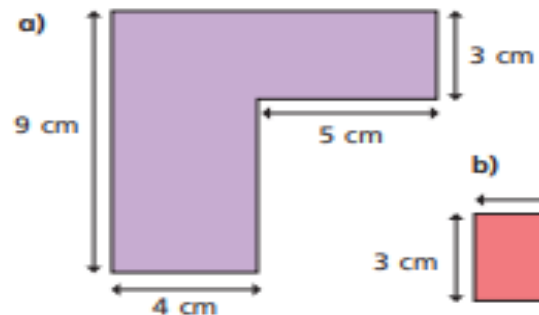

- 5 Mo puts two 5 cm by 3 cm rectangles next to each other.

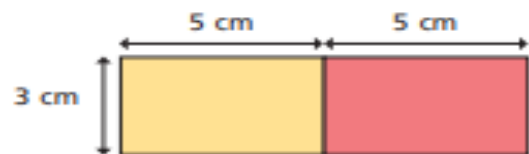

The perimeter of each small rectangle is 16 cm, so the perimeter of my larger rectangle must be $2 \times 16 \text{ cm} = 32 \text{ cm}$.

- a) Is Mo correct? _____

Work out the perimeter of the larger rectangle to check your answer.

- b) Mo puts the rectangles together in different ways.

Work out the perimeter of each large shape.

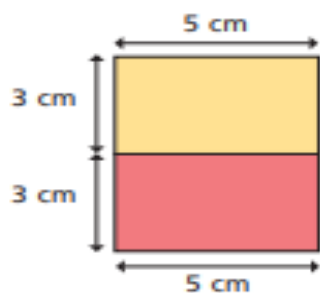

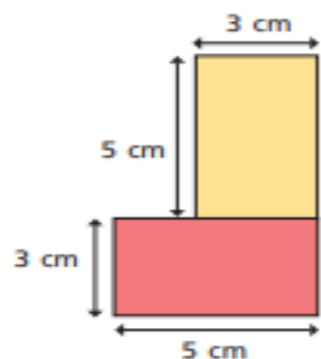

- 6 Dani thinks there isn't enough information to work out the perimeter of the shape.

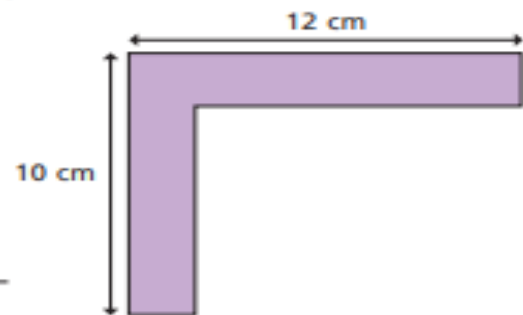

Is Dani correct? _____

Explain your answer.

- 7 A rectangular flower bed is 5 m long and 3 m wide. The path around the flower bed is 1 m wide.

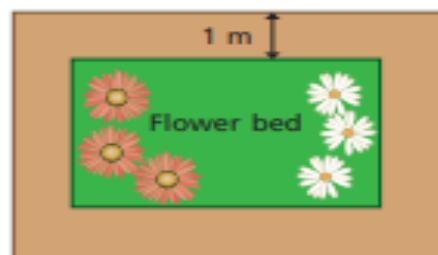

- a) What is the perimeter of the flower bed?

- b) What is the perimeter of the outside of the path?

Literacy

What Do You Notice About These Words?



discussion



profession



depression

This week we are looking at words which end with the sound /shun/ spelt 'ssion'...



expressio



discussion

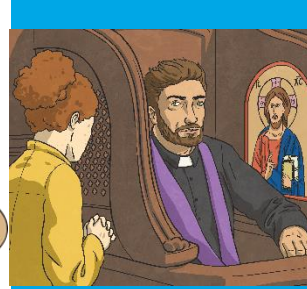

confessio



permissio

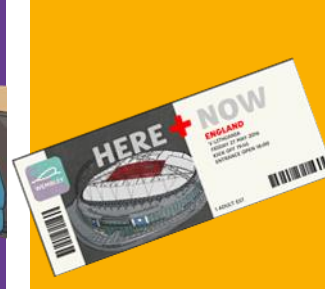

admission



transmissio

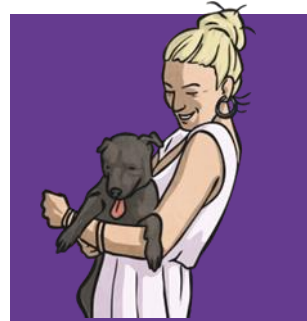

possessio



professio



depressio

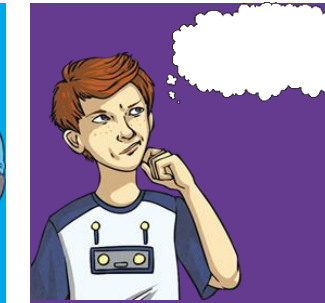

impressio

What do these words all have in common?
What do the root words end in? Can you see a pattern?

What do these words all have in common?

What do the root words end in? Can you see a pattern?



express

+ sion

= expression



transmit

+ sion

= transmission

Here are this week's spellings to practise.

expression

transmission

discussion

possession

confession

profession

permission

depression

admission

impression

Week 2

Words with the Ending /shuhn/
Spelt Using 'ssion'

expression transmission

discussion possession

confession profession

permission depression

admission impression

Words with the Ending /shuhn/

Spelt Using 'ssion'

i j o n o i s s e f o r p
e d t z n m o v r u r t n
r e l e o p n l i a n r o
n p n y i r o x n d x a i
o r c w s e i f o m r n s
i e o g s s s y i i w s s
s s j r u s s s s p m e
s s y z c i e e s s p i s
i i m w s o r u e i f s s
m o q u i n p q f o f s o
r n i l d l x o n n k i p
e t l e p t e t o a p o v
p s k v m f d q c c b n a

expression

admission

depression

discussion

transmission

impression

confession

possession

permission

profession



Words with the Ending /shuhn/ Spelt Using 'ssion'

Practise your weekly spelling words using cursive handwriting.

expression

discussion

confession

permission

admission

transmission

possession

profession

depression

impression

Remembrance Day



Remembrance Day is held on the 11th of November - the 11th day of the 11th month of the year. A two minute silence is always held at 11am to remember the millions who have died at war.

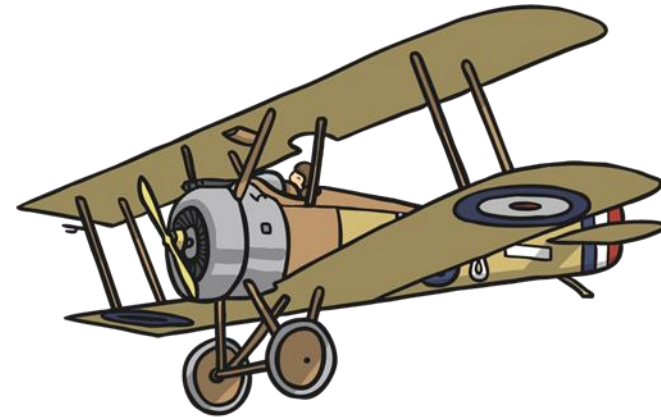
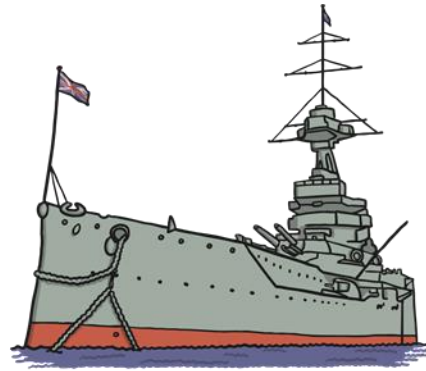

Remembrance Day was first held in 1919, one year after World War I ended. It is sometimes known as Armistice day.

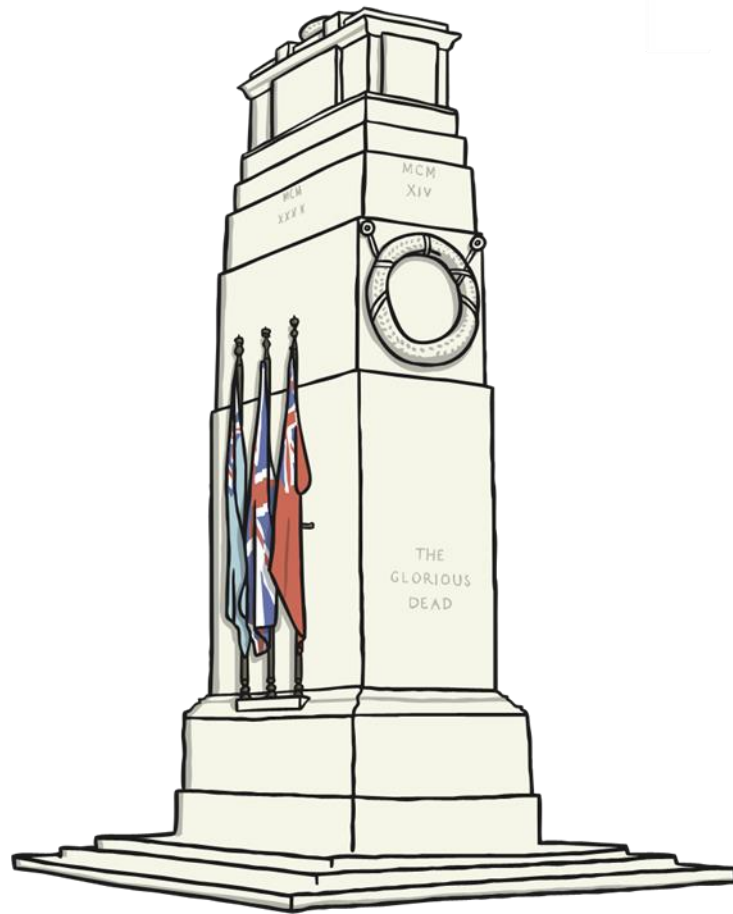

On Remembrance Day, people will lay wreaths of poppies on statues and monuments to remember all the soldiers who died for us.

Poppies are worn on Remembrance Day because they are the flowers which grew on the battlefields after World War I ended.





Today we use Remembrance Day to remember all those who have died
since World War 1

An organisation called the RSL (Returned and Services League) run the Poppy Appeal every year to raise money for men and women who have served or are serving in the Defence Force. They raise money by selling small poppies.

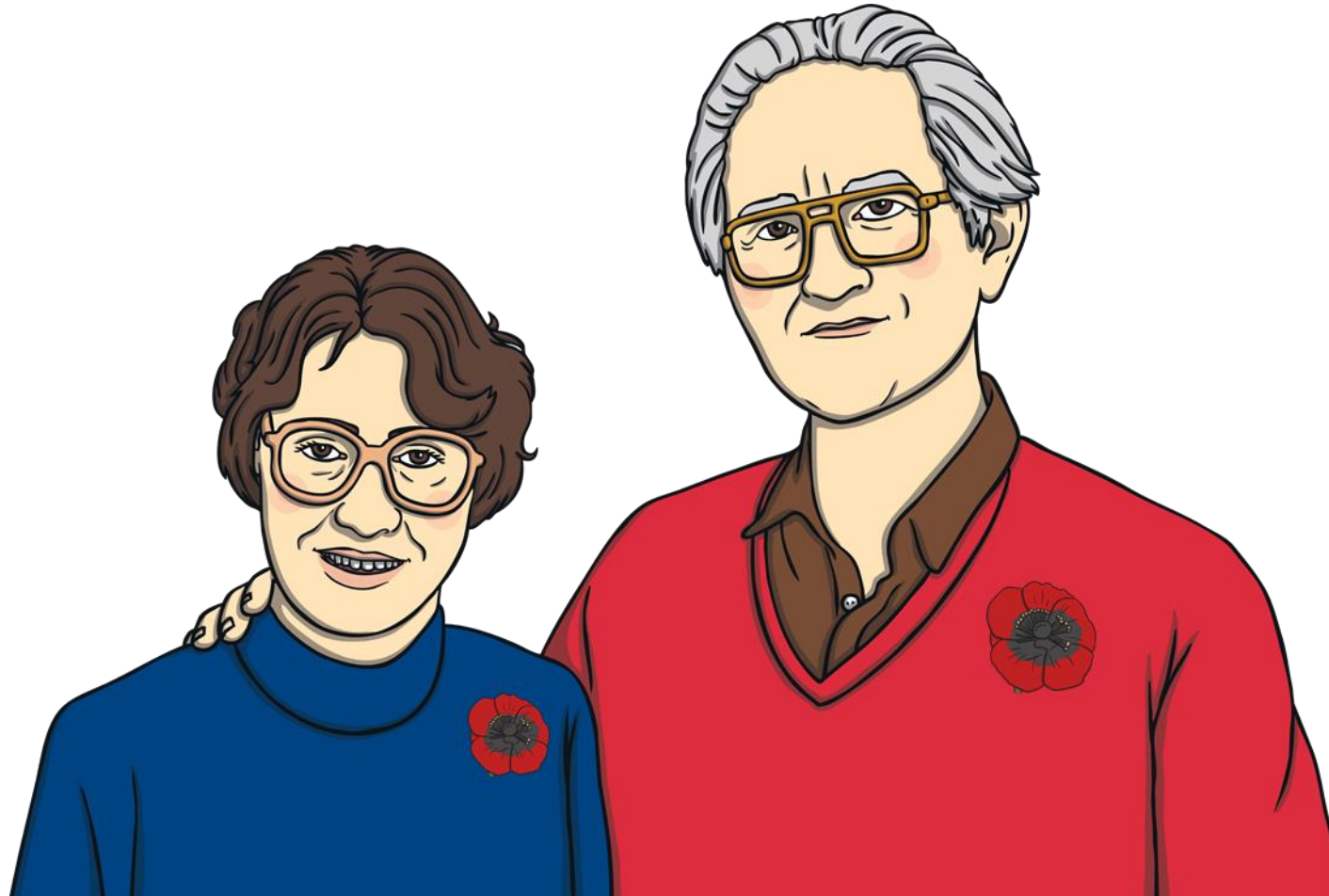

Questions

Answer the questions below in full sentences

1. When is Remembrance Day held each year?

2. Why is a two minute silence held each year?

3. What other name is Remembrance Day sometimes known as?

4. Why do people wear poppies on Remembrance Day?

5. What is the name of the charity which sells poppies each year? Why do they do this?

Acrostic Poem

- Challenge: Try to write your own acrostic poem linked to 'Remembrance Day'. The word is 'remember'.

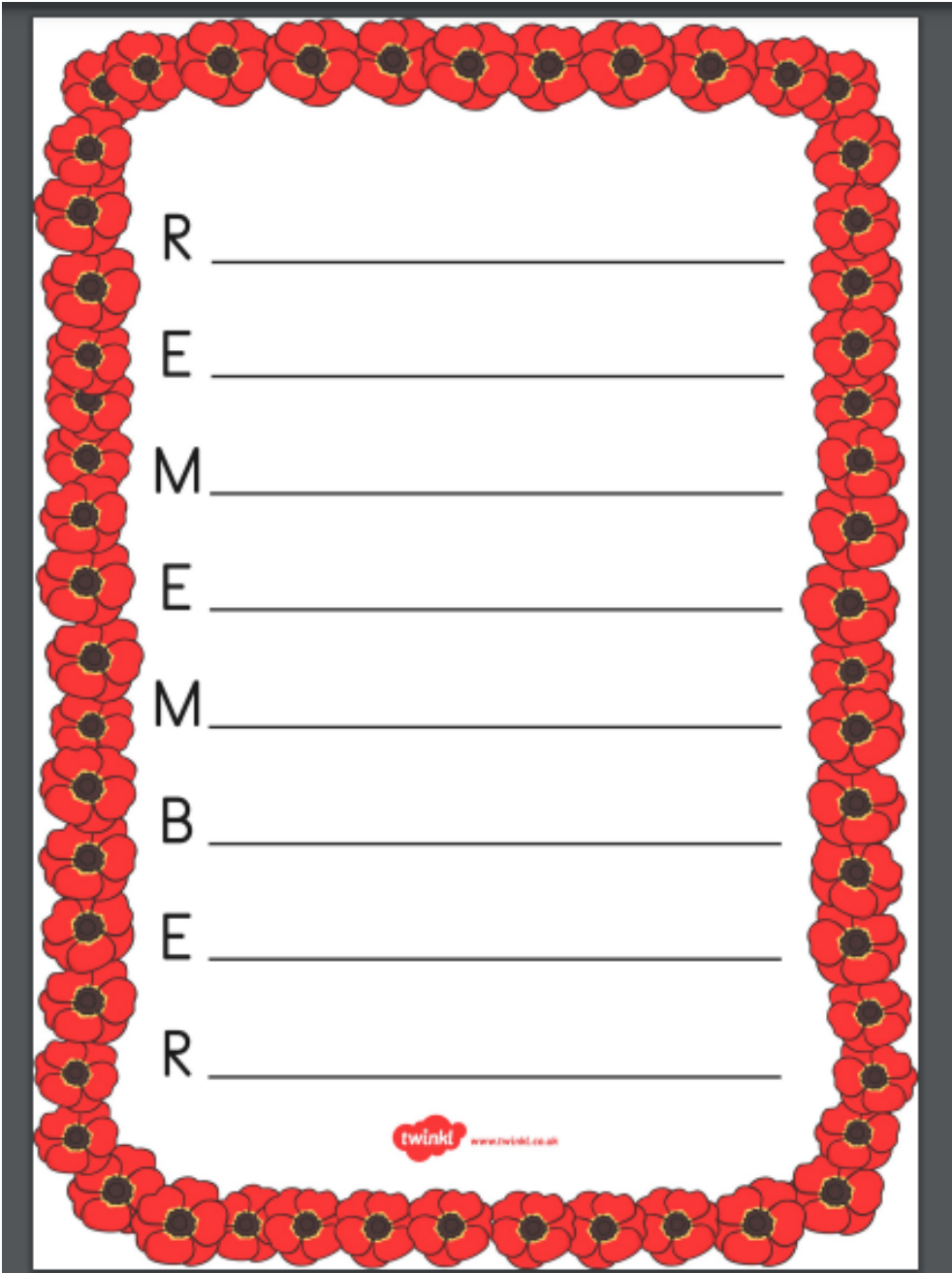

R

E

M

E

M

B

E

R

Art

Remembrance Day Art

- This week in Art we are doing a special activity on Remembrance Day.
- Please use the link below and follow the steps carefully to produce a piece of Remembrance Day Art.
- Link: <https://www.youtube.com/watch?v=NxjeL1WH4fA>